

# NAD-160/EN5424

EN 54-24 Ceiling-Speaker  
in ABS / ALU with 6 Watt Power

EN  
54-24

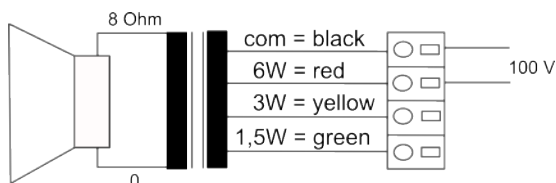
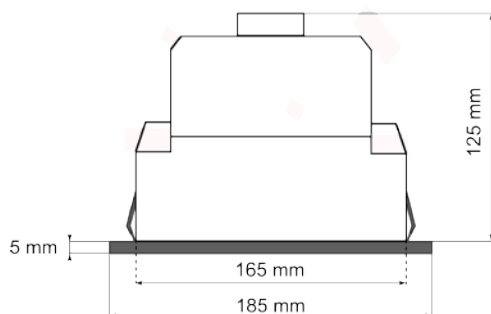

## TECHNICAL DATA

## NAD-160/EN5424

Loudspeaker:	6" broadband
Power-Consumption:	100V-6-3-1,5W
Frequency-Range:	200-20 000 Hz
EN-Sensitivity 1W/4M:	81 dB
SPL max 6W/4M:	88 dB
SPL 1W/1M max. EASE/Ulysses:	98 dB (3,5kHz)
SPL 6W/1M max. EASE/Ulysses:	107 dB (3,5 kHz)
Radiation H (0,5/1/2/4kHz):	180°/178°/150°/70°
Radiation V (0,5/1/2/4kHz):	180°/178°/150°/70°
Dimension:	185 mm x 125 mm
Ceiling Cut-out:	165 mm
Suitable slab thickness:	2 mm - 45 mm
Weight:	1 kg
Material:	ABS / ALU
Color:	white
Certificate-Nr.:	1293-CPR-0689
Order-Nr.:	NAD-160/EN5424

- Nearly rimless design
- Very fast mounting through Quick-Snap-System
- Wide radiation
- Two touch-secure 100V-tappings
- Integrated firedome
- Wetroom-version available (NAD-160-FR/EN5424)
- Custom color by request
- Ceramic clamp & thermal fuse by request

**NAD-160/EN5424**

EN 54-24 Ceiling-Speaker  
in ABS / ALU with 6 Watt Power

## Radiation

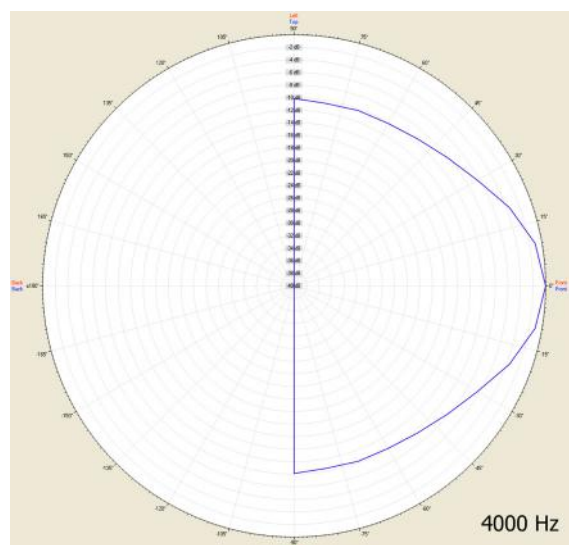
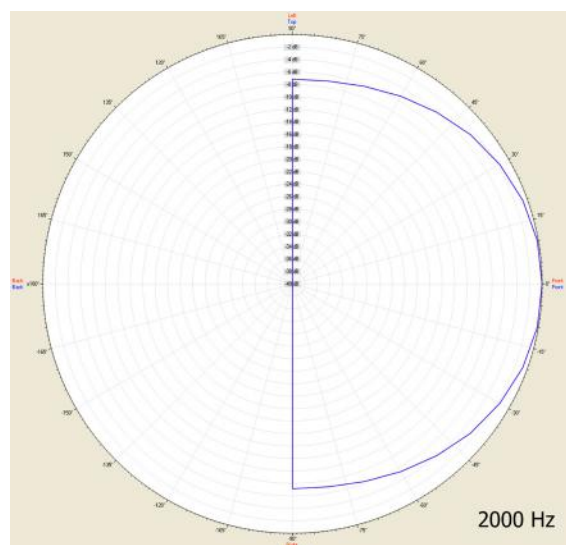
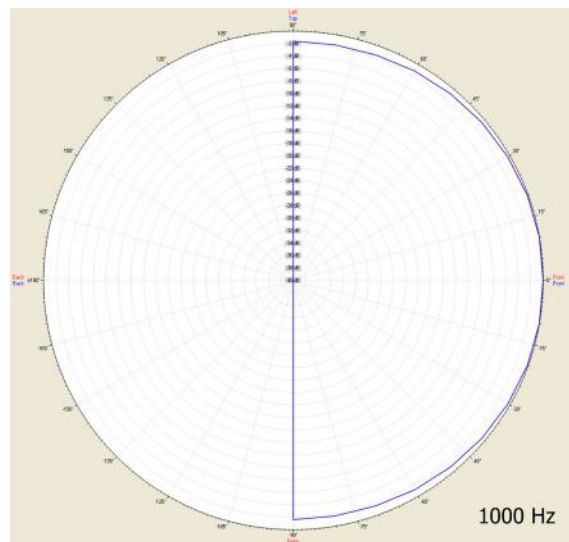
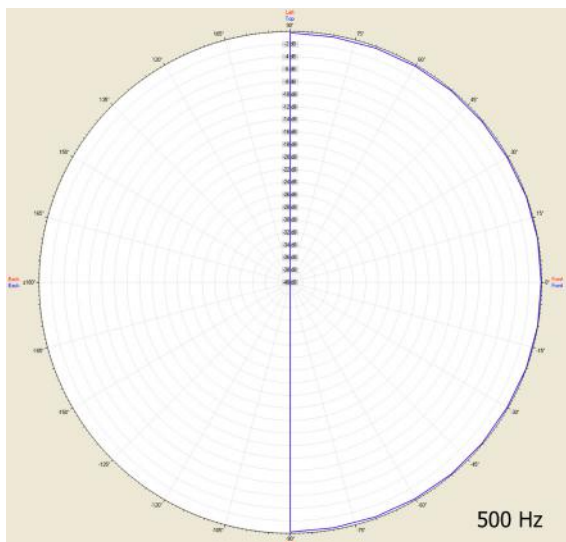

Test method	Axis	500 Hz	1000 Hz	2000 Hz	4000 Hz
EN 54-24	HOR	180°	178°	150°	70°
EN 54-24	VER	180°	178°	150°	70°
EASE/Ulysses	HOR	180°	180°	140°	60°
EASE/Ulysses	VER	180°	180°	140°	60°

# NAD-160/EN5424

EN 54-24 Ceiling-Speaker  
in ABS / ALU with 6 Watt Power



Elektroakustische Komponenten

## Isobar-diagram

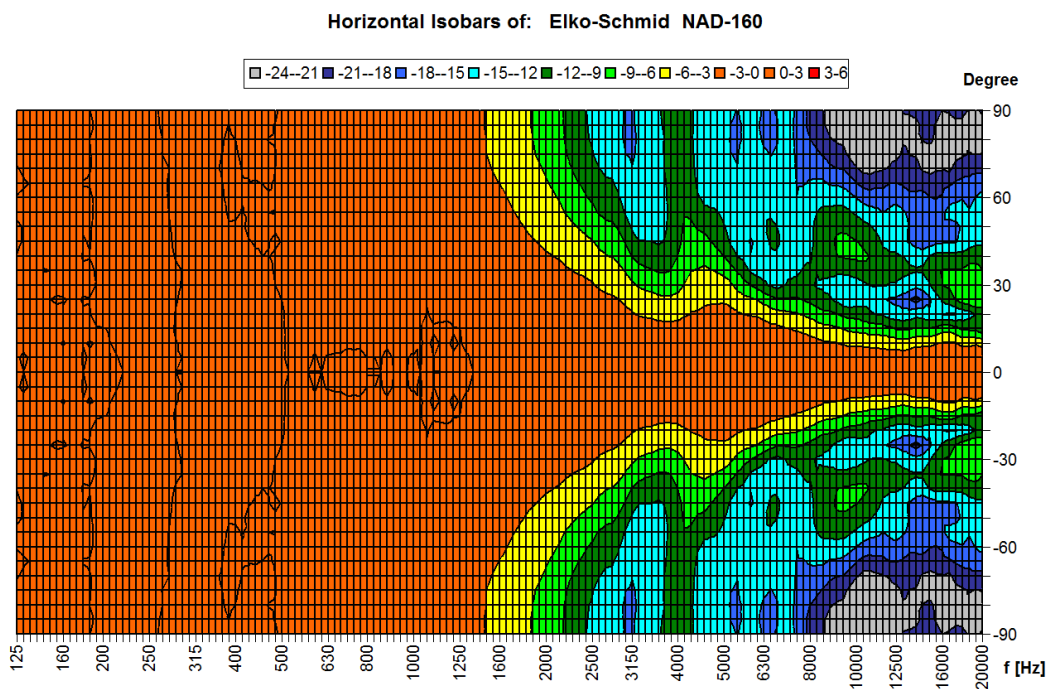

1293

Elko Schmid GmbH & Co. KG  
Glauchauer Str. 30, D-08058 Zwickau

20

DoP: 498058129314-ICS-PN-0030

EN 54-24

Loudspeaker for voice alarm systems for  
fire detection and fire alarm systems for buildings

NAD-160/EN5424

Intended Option:  
Type A